

BIOENGINEERING AND BIOMATERIALS GROUP

Wet Lab

Space Code: 1.1
 NASF/Unit: 900 sf
 Occupants: 6
 No. of Spaces: 7

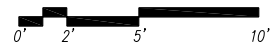
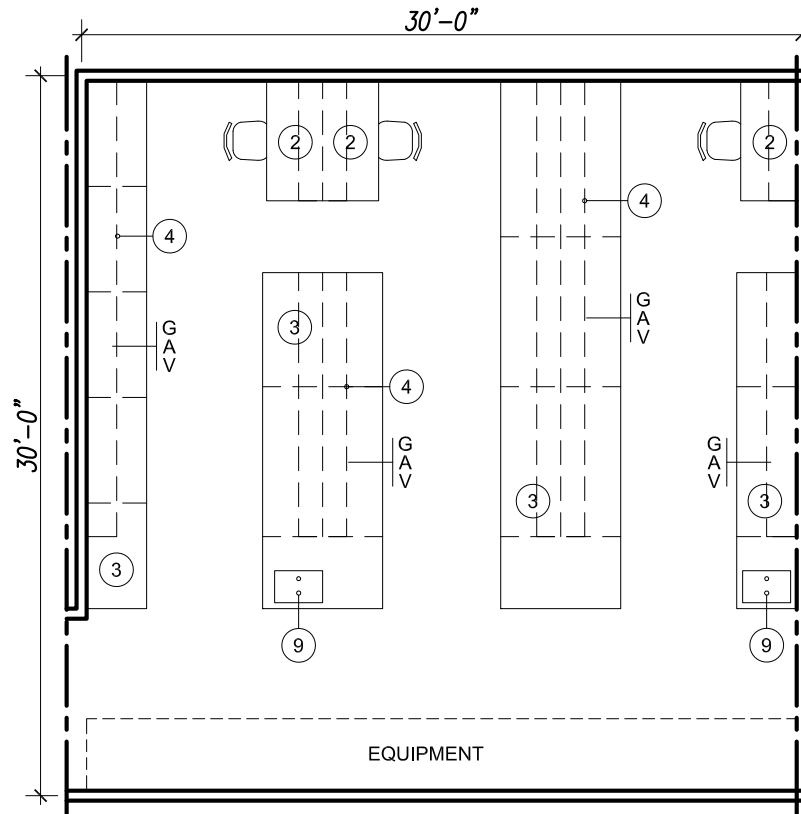

CASEWORK

1. Bench - Standing Height
2. Bench - Sitting Height
3. Bench - Movable
4. Wall Shelves
5. Wall Cabinet
6. Tall Storage Cabinet
7. Movable Table
8. Fixed Table
9. Sink

EQUIPMENT

20. Fume Hood
21. Biological Safety Cabinet
22. Refrigerator
23. Freezer
24. Incubator
25. Autoclave
26. Glassware Washer
27. Overhead Projector
28. Fluorescence Microscope
29. Optical Table
30. Equipment Rack
31. Curtains / Track

FURNISHINGS

40. Projection Screen
41. Whiteboard
42. Curtains & Tracks

SERVICES

- ⌀ Power
- ▽ Data
- G Gas
- A Air
- V Vacuum
- CW Cold Water
- PW Pure Water
- ES Emergency Shower

BIOENGINEERING AND BIOMATERIALS GROUP

Imaging Facility

Space Code: 1.2
 NASF/Unit: 750 sf
 Occupants: 3
 No. of Spaces: 1

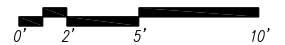
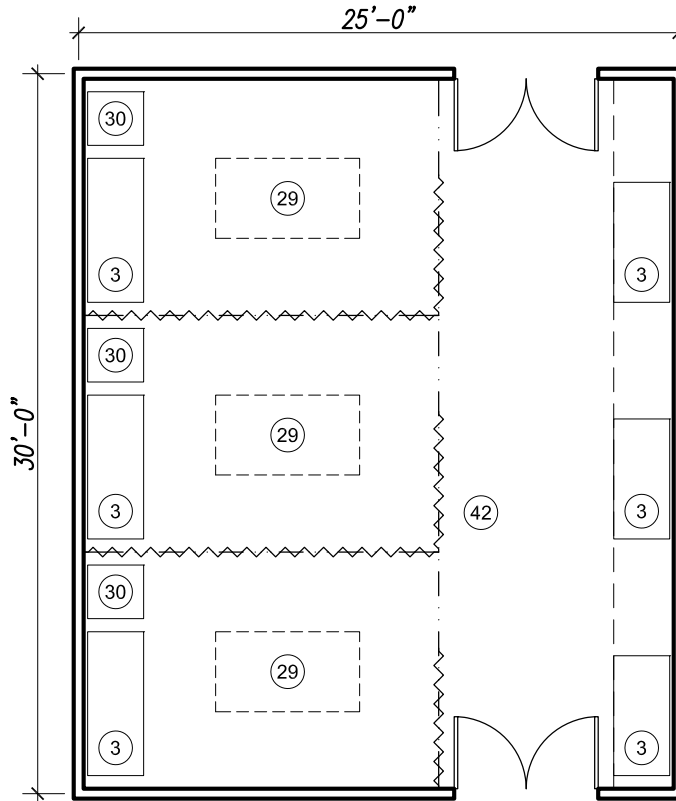

CASEWORK

1. Bench - Standing Height
2. Bench - Sitting Height
3. Bench - Movable
4. Wall Shelves
5. Wall Cabinet
6. Tall Storage Cabinet
7. Movable Table
8. Fixed Table
9. Sink

EQUIPMENT

20. Fume Hood
21. Biological Safety Cabinet
22. Refrigerator
23. Freezer
24. Incubator
25. Autoclave
26. Glassware Washer
27. Overhead Projector
28. Fluorescence Microscope
29. Optical Table
30. Equipment Rack
31. Curtains / Track

FURNISHINGS

40. Projection Screen
41. Whiteboard
42. Curtains & Tracks

SERVICES

- ⊕ Power
- ▽ Data
- G Gas
- A Air
- V Vacuum
- CW Cold Water
- PW Pure Water
- ES Emergency Shower

BIOENGINEERING AND BIOMATERIALS GROUP

Fume Hood Alcoves

Space Code: 1.3
 NASF/Unit: 100 sf
 Occupants: 1
 No. of Spaces: 4

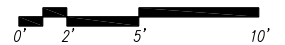
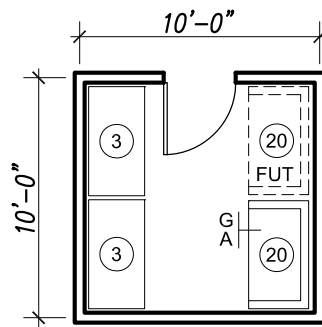

CASEWORK

1. Bench - Standing Height
2. Bench - Sitting Height
3. Bench - Movable
4. Wall Shelves
5. Wall Cabinet
6. Tall Storage Cabinet
7. Movable Table
8. Fixed Table
9. Sink

EQUIPMENT

20. Fume Hood
21. Biological Safety Cabinet
22. Refrigerator
23. Freezer
24. Incubator
25. Autoclave
26. Glassware Washer
27. Overhead Projector
28. Fluorescence Microscope
29. Optical Table
30. Equipment Rack
31. Curtains / Track

FURNISHINGS

40. Projection Screen
41. Whiteboard
42. Curtains & Tracks

SERVICES

- ⌀ Power
- ▽ Data
- G Gas
- A Air
- V Vacuum
- CW Cold Water
- PW Pure Water
- ES Emergency Shower

BIOENGINEERING AND BIOMATERIALS GROUP

Tissue Culture Facility

Space Code: 1.4
 NASF/Unit: 300 sf
 Occupants: 4
 No. of Spaces: 1

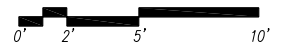
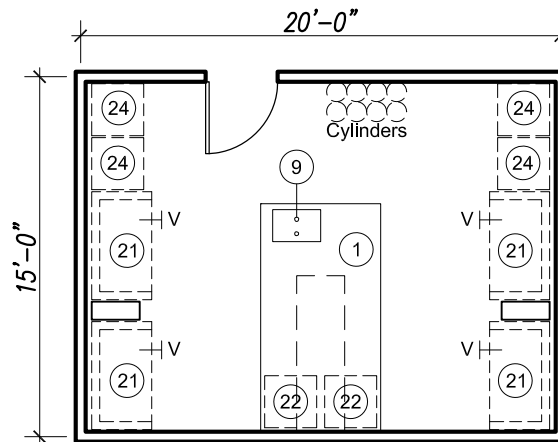

CASEWORK

1. Bench - Standing Height
2. Bench - Sitting Height
3. Bench - Movable
4. Wall Shelves
5. Wall Cabinet
6. Tall Storage Cabinet
7. Movable Table
8. Fixed Table
9. Sink

EQUIPMENT

20. Fume Hood
21. Biological Safety Cabinet
22. Refrigerator
23. Freezer
24. Incubator
25. Autoclave
26. Glassware Washer
27. Overhead Projector
28. Fluorescence Microscope
29. Optical Table
30. Equipment Rack
31. Curtains / Track

FURNISHINGS

40. Projection Screen
41. Whiteboard
42. Curtains & Tracks

SERVICES

- ⊕ Power
- ▽ Data
- G Gas
- A Air
- V Vacuum
- CW Cold Water
- PW Pure Water
- ES Emergency Shower

Shared Equipment

Space Code: 1.5
 NASF/Unit: 300 sf
 Occupants: -
 No. of Spaces: 2

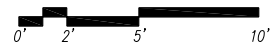
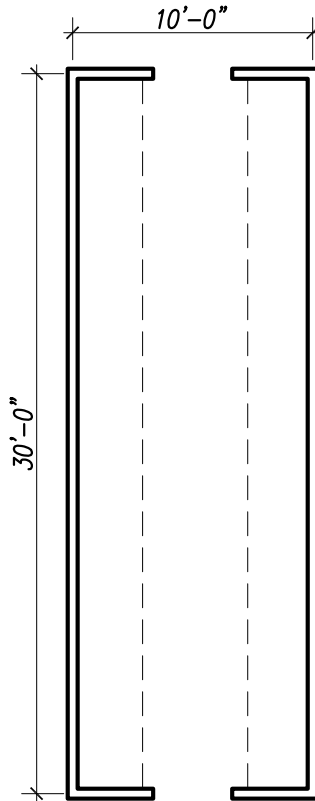

CASEWORK

1. Bench - Standing Height
2. Bench - Sitting Height
3. Bench - Movable
4. Wall Shelves
5. Wall Cabinet
6. Tall Storage Cabinet
7. Movable Table
8. Fixed Table
9. Sink

EQUIPMENT

20. Fume Hood
21. Biological Safety Cabinet
22. Refrigerator
23. Freezer
24. Incubator
25. Autoclave
26. Glassware Washer
27. Overhead Projector
28. Fluorescence Microscope
29. Optical Table
30. Equipment Rack
31. Curtains / Track

FURNISHINGS

40. Projection Screen
41. Whiteboard
42. Curtains & Tracks

SERVICES

- ⌀ Power
- ▽ Data
- G Gas
- A Air
- V Vacuum
- CW Cold Water
- PW Pure Water
- ES Emergency Shower

Lab Support

Space Code: 1.6
 NASF/Unit: 150 sf
 Occupants: 1
 No. of Spaces: 4

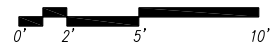
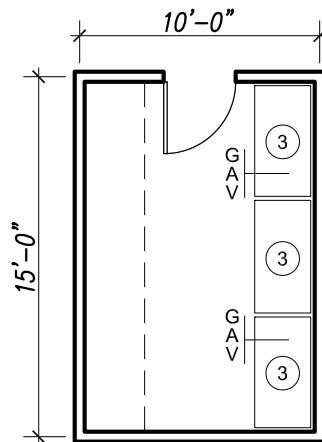

CASEWORK

1. Bench - Standing Height
2. Bench - Sitting Height
3. Bench - Movable
4. Wall Shelves
5. Wall Cabinet
6. Tall Storage Cabinet
7. Movable Table
8. Fixed Table
9. Sink

EQUIPMENT

20. Fume Hood
21. Biological Safety Cabinet
22. Refrigerator
23. Freezer
24. Incubator
25. Autoclave
26. Glassware Washer
27. Overhead Projector
28. Fluorescence Microscope
29. Optical Table
30. Equipment Rack
31. Curtains / Track

FURNISHINGS

40. Projection Screen
41. Whiteboard
42. Curtains & Tracks

SERVICES

- ⌀ Power
- ▽ Data
- G Gas
- A Air
- V Vacuum
- CW Cold Water
- PW Pure Water
- ES Emergency Shower

BIOENGINEERING AND BIOMATERIALS GROUP

Grad Student / Post-Doc Offices

Space Code: 1.7
NASF/Unit: 200 sf
Occupants: 4-6
No. of Spaces: 7

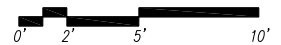
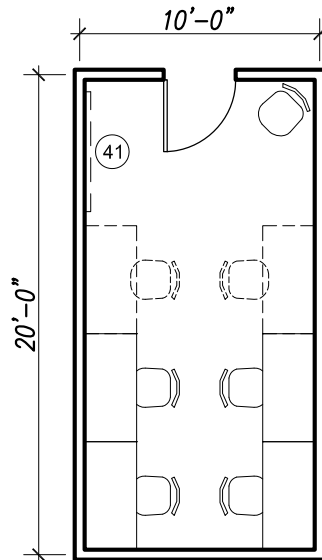

CASEWORK

1. Bench - Standing Height
2. Bench - Sitting Height
3. Bench - Movable
4. Wall Shelves
5. Wall Cabinet
6. Tall Storage Cabinet
7. Movable Table
8. Fixed Table
9. Sink

EQUIPMENT

20. Fume Hood
21. Biological Safety Cabinet
22. Refrigerator
23. Freezer
24. Incubator
25. Autoclave
26. Glassware Washer
27. Overhead Projector
28. Fluorescence Microscope
29. Optical Table
30. Equipment Rack
31. Curtains / Track

FURNISHINGS

40. Projection Screen
41. Whiteboard
42. Curtains & Tracks

SERVICES

- ⌀ Power
- ▽ Data
- G Gas
- A Air
- V Vacuum
- CW Cold Water
- PW Pure Water
- ES Emergency Shower

Space Code: 1.8
 NASF/Unit: 200 sf
 Occupants: 2
 No. of Spaces: 1

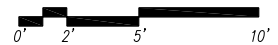
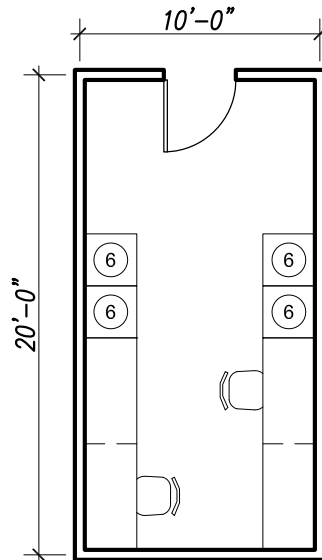

CASEWORK

1. Bench - Standing Height
2. Bench - Sitting Height
3. Bench - Movable
4. Wall Shelves
5. Wall Cabinet
6. Tall Storage Cabinet
7. Movable Table
8. Fixed Table
9. Sink

EQUIPMENT

20. Fume Hood
21. Biological Safety Cabinet
22. Refrigerator
23. Freezer
24. Incubator
25. Autoclave
26. Glassware Washer
27. Overhead Projector
28. Fluorescence Microscope
29. Optical Table
30. Equipment Rack
31. Curtains / Track

FURNISHINGS

40. Projection Screen
41. Whiteboard
42. Curtains & Tracks

SERVICES

- ⌀ Power
- ▽ Data
- G Gas
- A Air
- V Vacuum
- CW Cold Water
- PW Pure Water
- ES Emergency Shower

BIOENGINEERING AND BIOMATERIALS GROUP

Meeting / Breakout Space

Space Code: 1.9
 NASF/Unit: 400 sf
 Occupants: -
 No. of Spaces: 2

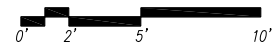
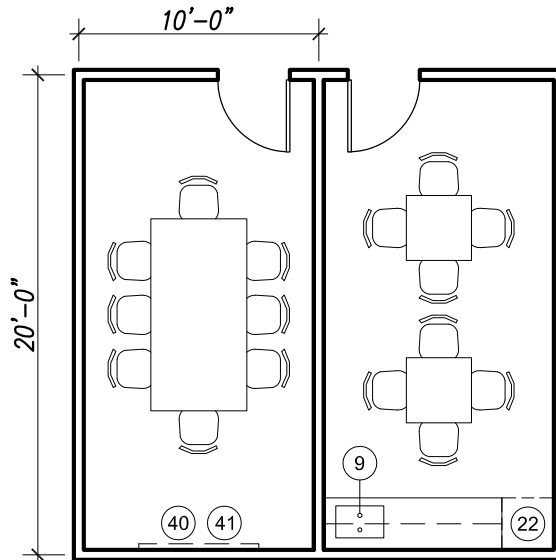

CASEWORK

1. Bench - Standing Height
2. Bench - Sitting Height
3. Bench - Movable
4. Wall Shelves
5. Wall Cabinet
6. Tall Storage Cabinet
7. Movable Table
8. Fixed Table
9. Sink

EQUIPMENT

20. Fume Hood
21. Biological Safety Cabinet
22. Refrigerator
23. Freezer
24. Incubator
25. Autoclave
26. Glassware Washer
27. Overhead Projector
28. Fluorescence Microscope
29. Optical Table
30. Equipment Rack
31. Curtains / Track

FURNISHINGS

40. Projection Screen
41. Whiteboard
42. Curtains & Tracks

SERVICES

- ⊕ Power
- ▽ Data
- G Gas
- A Air
- V Vacuum
- CW Cold Water
- PW Pure Water
- ES Emergency Shower

Space Code: 2.1
 NASF/Unit: 900 sf
 Occupants: 6
 No. of Spaces: 5

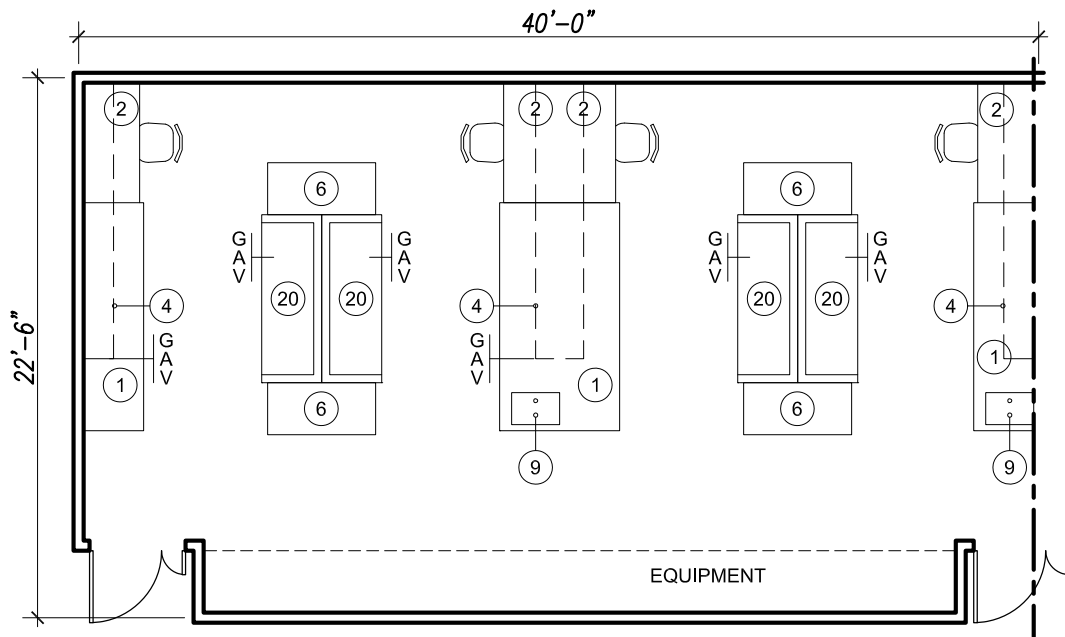

CASEWORK

1. Bench - Standing Height
2. Bench - Sitting Height
3. Bench - Movable
4. Wall Shelves
5. Wall Cabinet
6. Tall Storage Cabinet
7. Movable Table
8. Fixed Table
9. Sink

EQUIPMENT

20. Fume Hood
21. Biological Safety Cabinet
22. Refrigerator
23. Freezer
24. Incubator
25. Autoclave
26. Glassware Washer
27. Overhead Projector
28. Fluorescence Microscope
29. Optical Table
30. Equipment Rack
31. Curtains / Track

FURNISHINGS

40. Projection Screen
41. Whiteboard
42. Curtains & Tracks

SERVICES

- ⊕ Power
- ▽ Data
- G Gas
- A Air
- V Vacuum
- CW Cold Water
- PW Pure Water
- ES Emergency Shower

Imaging / Characterization

Space Code: 2.2
 NASF/Unit: 600 sf
 Occupants:
 No. of Spaces: 2

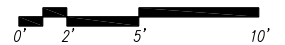
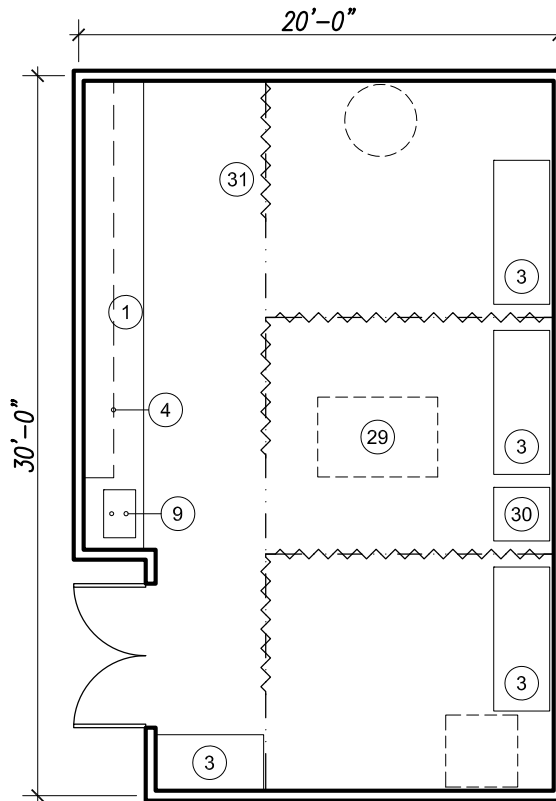

CASEWORK

1. Bench - Standing Height
2. Bench - Sitting Height
3. Bench - Movable
4. Wall Shelves
5. Wall Cabinet
6. Tall Storage Cabinet
7. Movable Table
8. Fixed Table
9. Sink

EQUIPMENT

20. Fume Hood
21. Biological Safety Cabinet
22. Refrigerator
23. Freezer
24. Incubator
25. Autoclave
26. Glassware Washer
27. Overhead Projector
28. Fluorescence Microscope
29. Optical Table
30. Equipment Rack
31. Curtains / Track

FURNISHINGS

40. Projection Screen
41. Whiteboard
42. Curtains & Tracks

SERVICES

- ⊕ Power
- ▽ Data
- G Gas
- A Air
- V Vacuum
- CW Cold Water
- PW Pure Water
- ES Emergency Shower

Shared Instruments

Space Code: 2.3
 NASF/Unit: 600 sf
 Occupants:
 No. of Spaces: 1

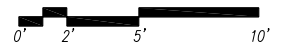
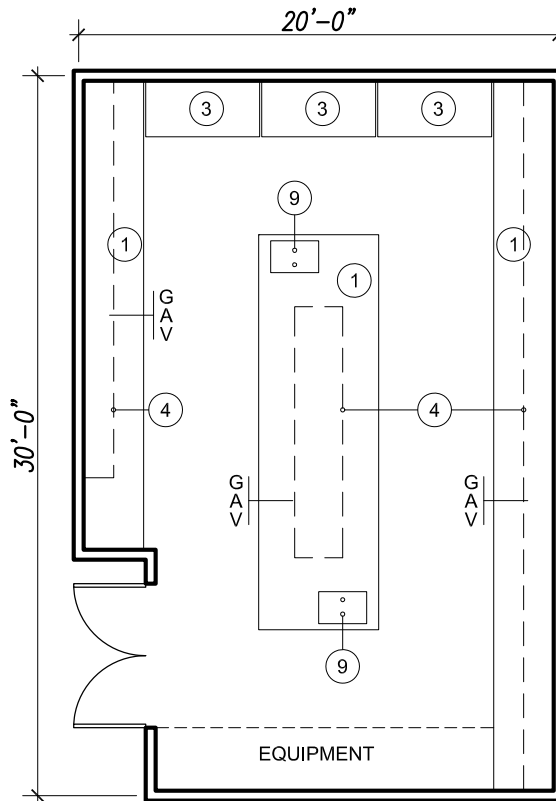

CASEWORK

1. Bench - Standing Height
2. Bench - Sitting Height
3. Bench - Movable
4. Wall Shelves
5. Wall Cabinet
6. Tall Storage Cabinet
7. Movable Table
8. Fixed Table
9. Sink

EQUIPMENT

20. Fume Hood
21. Biological Safety Cabinet
22. Refrigerator
23. Freezer
24. Incubator
25. Autoclave
26. Glassware Washer
27. Overhead Projector
28. Fluorescence Microscope
29. Optical Table
30. Equipment Rack
31. Curtains / Track

FURNISHINGS

40. Projection Screen
41. Whiteboard
42. Curtains & Tracks

SERVICES

- ⊕ Power
- ▽ Data
- G Gas
- A Air
- V Vacuum
- CW Cold Water
- PW Pure Water
- ES Emergency Shower

CHEMICAL ENGINEERING GROUP

Micro-Fabrication Facility

Space Code: 2.4
 NASF/Unit: 600 sf
 Occupants:
 No. of Spaces: 1

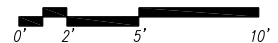
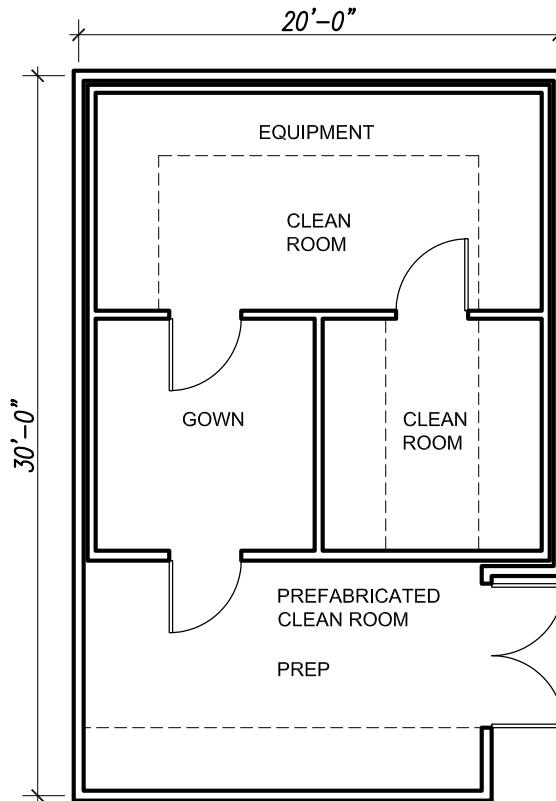

CASEWORK

1. Bench - Standing Height
2. Bench - Sitting Height
3. Bench - Movable
4. Wall Shelves
5. Wall Cabinet
6. Tall Storage Cabinet
7. Movable Table
8. Fixed Table
9. Sink

EQUIPMENT

20. Fume Hood
21. Biological Safety Cabinet
22. Refrigerator
23. Freezer
24. Incubator
25. Autoclave
26. Glassware Washer
27. Overhead Projector
28. Fluorescence Microscope
29. Optical Table
30. Equipment Rack
31. Curtains / Track

FURNISHINGS

40. Projection Screen
41. Whiteboard
42. Curtains & Tracks

SERVICES

- ⌀ Power
- ▽ Data
- G Gas
- A Air
- V Vacuum
- CW Cold Water
- PW Pure Water
- ES Emergency Shower

Lab Support

Space Code: 2.5
 NASF/Unit: 200 sf
 Occupants:
 No. of Spaces: 4

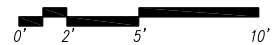
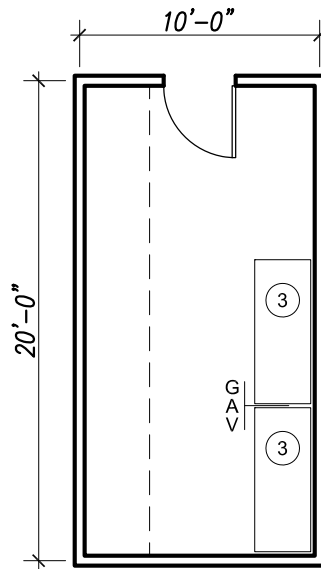

CASEWORK

1. Bench - Standing Height
2. Bench - Sitting Height
3. Bench - Movable
4. Wall Shelves
5. Wall Cabinet
6. Tall Storage Cabinet
7. Movable Table
8. Fixed Table
9. Sink

EQUIPMENT

20. Fume Hood
21. Biological Safety Cabinet
22. Refrigerator
23. Freezer
24. Incubator
25. Autoclave
26. Glassware Washer
27. Overhead Projector
28. Fluorescence Microscope
29. Optical Table
30. Equipment Rack
31. Curtains / Track

FURNISHINGS

40. Projection Screen
41. Whiteboard
42. Curtains & Tracks

SERVICES

- ⌀ Power
- ▽ Data
- G Gas
- A Air
- V Vacuum
- CW Cold Water
- PW Pure Water
- ES Emergency Shower

Cylinder Storage

Space Code: 2.6
 NASF/Unit: 150 sf
 Occupants: 0
 No. of Spaces: 2

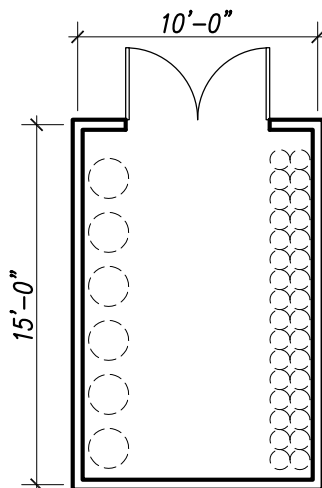

CASEWORK

1. Bench - Standing Height
2. Bench - Sitting Height
3. Bench - Movable
4. Wall Shelves
5. Wall Cabinet
6. Tall Storage Cabinet
7. Movable Table
8. Fixed Table
9. Sink

EQUIPMENT

20. Fume Hood
21. Biological Safety Cabinet
22. Refrigerator
23. Freezer
24. Incubator
25. Autoclave
26. Glassware Washer
27. Overhead Projector
28. Fluorescence Microscope
29. Optical Table
30. Equipment Rack
31. Curtains / Track

FURNISHINGS

40. Projection Screen
41. Whiteboard
42. Curtains & Tracks

SERVICES

- ⌀ Power
- ▽ Data
- G Gas
- A Air
- V Vacuum
- CW Cold Water
- PW Pure Water
- ES Emergency Shower

Space Code: 2.7
 NASF/Unit: 200 sf
 Occupants: 4-6
 No. of Spaces: 7

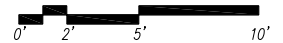
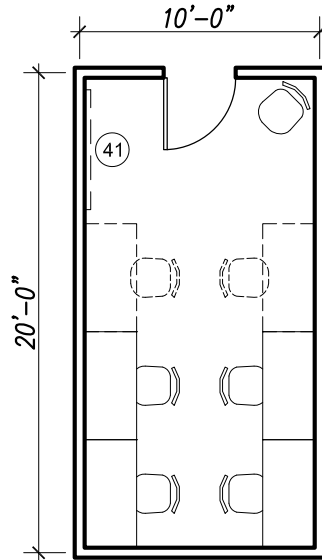

CASEWORK

1. Bench - Standing Height
2. Bench - Sitting Height
3. Bench - Movable
4. Wall Shelves
5. Wall Cabinet
6. Tall Storage Cabinet
7. Movable Table
8. Fixed Table
9. Sink

EQUIPMENT

20. Fume Hood
21. Biological Safety Cabinet
22. Refrigerator
23. Freezer
24. Incubator
25. Autoclave
26. Glassware Washer
27. Overhead Projector
28. Fluorescence Microscope
29. Optical Table
30. Equipment Rack
31. Curtains / Track

FURNISHINGS

40. Projection Screen
41. Whiteboard
42. Curtains & Tracks

SERVICES

- ⌀ Power
- ▽ Data
- G Gas
- A Air
- V Vacuum
- CW Cold Water
- PW Pure Water
- ES Emergency Shower

Space Code: 2.8
 NASF/Unit: 200 sf
 Occupants: 2
 No. of Spaces: 1

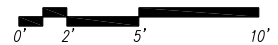
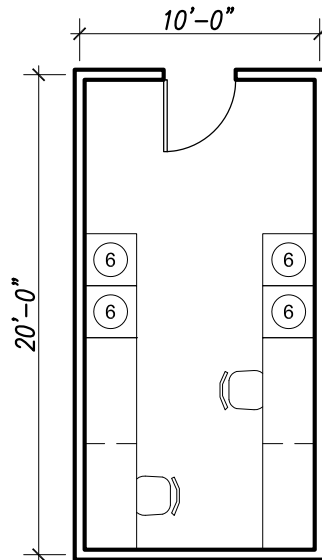

CASEWORK

1. Bench - Standing Height
2. Bench - Sitting Height
3. Bench - Movable
4. Wall Shelves
5. Wall Cabinet
6. Tall Storage Cabinet
7. Movable Table
8. Fixed Table
9. Sink

EQUIPMENT

20. Fume Hood
21. Biological Safety Cabinet
22. Refrigerator
23. Freezer
24. Incubator
25. Autoclave
26. Glassware Washer
27. Overhead Projector
28. Fluorescence Microscope
29. Optical Table
30. Equipment Rack
31. Curtains / Track

FURNISHINGS

40. Projection Screen
41. Whiteboard
42. Curtains & Tracks

SERVICES

- ⌀ Power
- ▽ Data
- G Gas
- A Air
- V Vacuum
- CW Cold Water
- PW Pure Water
- ES Emergency Shower

CHEMICAL ENGINEERING GROUP

Meeting / Breakout Space

Space Code: 2.9
 NASF/Unit: 400 sf
 Occupants: -
 No. of Spaces: 2

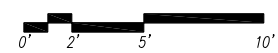
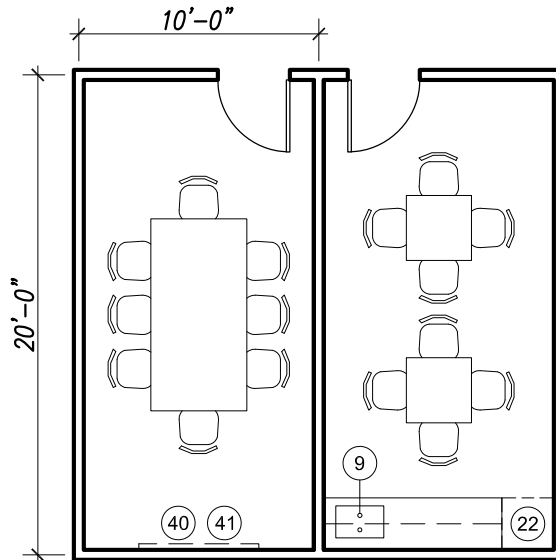

CASEWORK

1. Bench - Standing Height
2. Bench - Sitting Height
3. Bench - Movable
4. Wall Shelves
5. Wall Cabinet
6. Tall Storage Cabinet
7. Movable Table
8. Fixed Table
9. Sink

EQUIPMENT

20. Fume Hood
21. Biological Safety Cabinet
22. Refrigerator
23. Freezer
24. Incubator
25. Autoclave
26. Glassware Washer
27. Overhead Projector
28. Fluorescence Microscope
29. Optical Table
30. Equipment Rack
31. Curtains / Track

FURNISHINGS

40. Projection Screen
41. Whiteboard
42. Curtains & Tracks

SERVICES

- ⌀ Power
- ▽ Data
- G Gas
- A Air
- V Vacuum
- CW Cold Water
- PW Pure Water
- ES Emergency Shower

COMPUTING, VR, AND SIMULATION

Virtual Reality Space

Space Code: 3.1
 NASF/Unit: 1,200 sf
 Occupants:
 No. of Spaces: 2

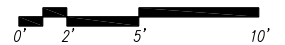
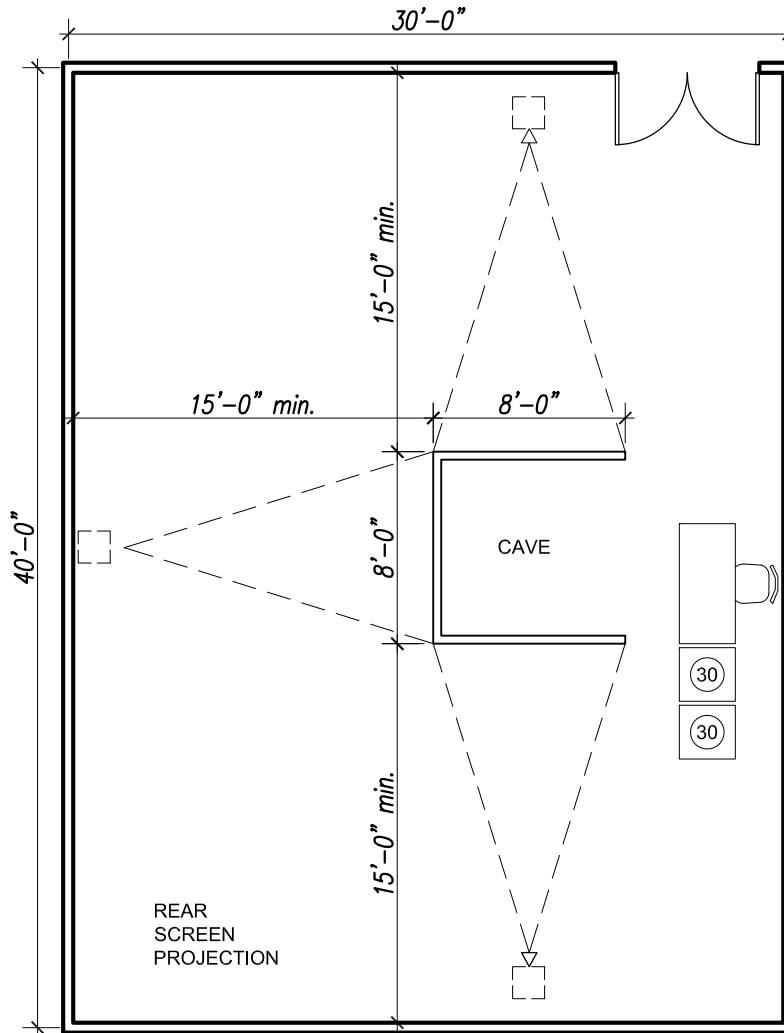

CASEWORK

1. Bench - Standing Height
2. Bench - Sitting Height
3. Bench - Movable
4. Wall Shelves
5. Wall Cabinet
6. Tall Storage Cabinet
7. Movable Table
8. Fixed Table
9. Sink

EQUIPMENT

20. Fume Hood
21. Biological Safety Cabinet
22. Refrigerator
23. Freezer
24. Incubator
25. Autoclave
26. Glassware Washer
27. Overhead Projector
28. Fluorescence Microscope
29. Optical Table
30. Equipment Rack
31. Curtains / Track

FURNISHINGS

40. Projection Screen
41. Whiteboard
42. Curtains & Tracks

SERVICES

- ⌀ Power
- ▽ Data
- G Gas
- A Air
- V Vacuum
- CW Cold Water
- PW Pure Water
- ES Emergency Shower

COMPUTING, VR, AND SIMULATION

Lab Support

Space Code: 3.2
NASF/Unit: 400 sf
Occupants:
No. of Spaces: 1

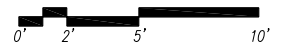
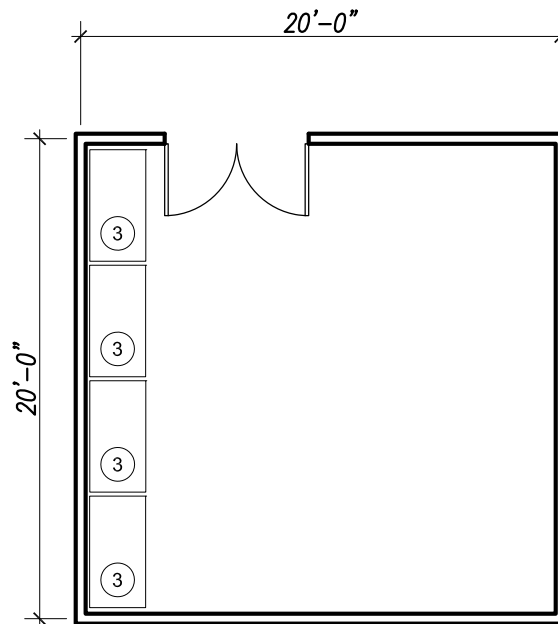

CASEWORK

1. Bench - Standing Height
2. Bench - Sitting Height
3. Bench - Movable
4. Wall Shelves
5. Wall Cabinet
6. Tall Storage Cabinet
7. Movable Table
8. Fixed Table
9. Sink

EQUIPMENT

20. Fume Hood
21. Biological Safety Cabinet
22. Refrigerator
23. Freezer
24. Incubator
25. Autoclave
26. Glassware Washer
27. Overhead Projector
28. Fluorescence Microscope
29. Optical Table
30. Equipment Rack
31. Curtains / Track

FURNISHINGS

40. Projection Screen
41. Whiteboard
42. Curtains & Tracks

SERVICES

- ⌀ Power
- ▽ Data
- G Gas
- A Air
- V Vacuum
- CW Cold Water
- PW Pure Water
- ES Emergency Shower

COMPUTING, VR, AND SIMULATION

Grad Student / Post-Doc Offices

Space Code: 3.3
NASF/Unit: 200 sf
Occupants: 4-6
No. of Spaces: 7

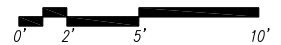
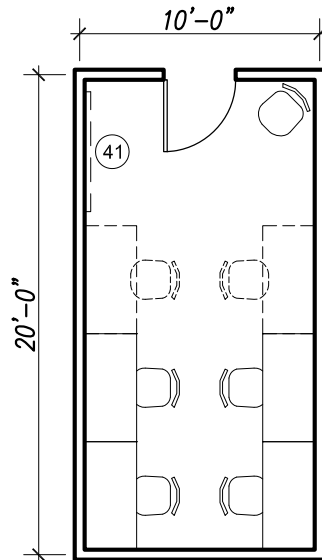

CASEWORK

1. Bench - Standing Height
2. Bench - Sitting Height
3. Bench - Movable
4. Wall Shelves
5. Wall Cabinet
6. Tall Storage Cabinet
7. Movable Table
8. Fixed Table
9. Sink

EQUIPMENT

20. Fume Hood
21. Biological Safety Cabinet
22. Refrigerator
23. Freezer
24. Incubator
25. Autoclave
26. Glassware Washer
27. Overhead Projector
28. Fluorescence Microscope
29. Optical Table
30. Equipment Rack
31. Curtains / Track

FURNISHINGS

40. Projection Screen
41. Whiteboard
42. Curtains & Tracks

SERVICES

- ⌀ Power
- ▽ Data
- G Gas
- A Air
- V Vacuum
- CW Cold Water
- PW Pure Water
- ES Emergency Shower

COMPUTING, VR, AND SIMULATION

Tech Office

Space Code: 3.4
NASF/Unit: 200 sf
Occupants: 2
No. of Spaces: 1

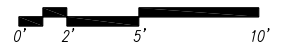
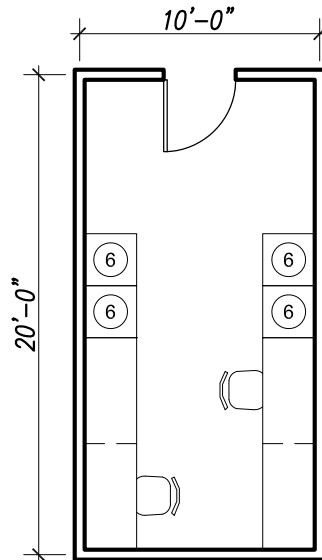

CASEWORK

1. Bench - Standing Height
2. Bench - Sitting Height
3. Bench - Movable
4. Wall Shelves
5. Wall Cabinet
6. Tall Storage Cabinet
7. Movable Table
8. Fixed Table
9. Sink

EQUIPMENT

20. Fume Hood
21. Biological Safety Cabinet
22. Refrigerator
23. Freezer
24. Incubator
25. Autoclave
26. Glassware Washer
27. Overhead Projector
28. Fluorescence Microscope
29. Optical Table
30. Equipment Rack
31. Curtains / Track

FURNISHINGS

40. Projection Screen
41. Whiteboard
42. Curtains & Tracks

SERVICES

- ⌀ Power
- ▽ Data
- G Gas
- A Air
- V Vacuum
- CW Cold Water
- PW Pure Water
- ES Emergency Shower

COMPUTING, VR, AND SIMULATION

Meeting / Breakout Space

Space Code: 3.5
 NASF/Unit: 400 sf
 Occupants: -
 No. of Spaces: 1

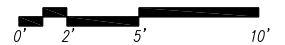
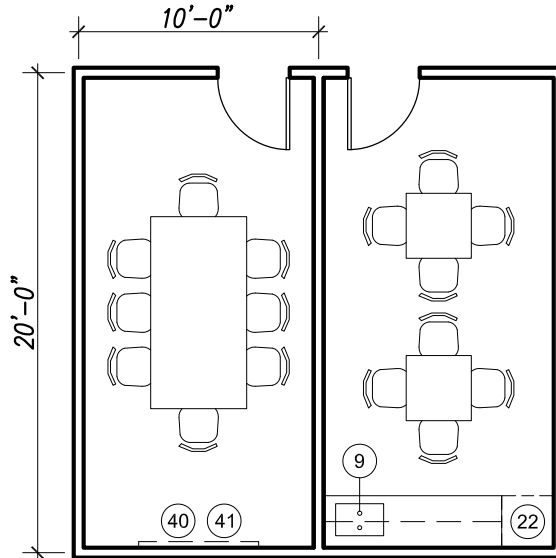

CASEWORK

1. Bench - Standing Height
2. Bench - Sitting Height
3. Bench - Movable
4. Wall Shelves
5. Wall Cabinet
6. Tall Storage Cabinet
7. Movable Table
8. Fixed Table
9. Sink

EQUIPMENT

20. Fume Hood
21. Biological Safety Cabinet
22. Refrigerator
23. Freezer
24. Incubator
25. Autoclave
26. Glassware Washer
27. Overhead Projector
28. Fluorescence Microscope
29. Optical Table
30. Equipment Rack
31. Curtains / Track

FURNISHINGS

40. Projection Screen
41. Whiteboard
42. Curtains & Tracks

SERVICES

- ⊕ Power
- ▽ Data
- G Gas
- A Air
- V Vacuum
- CW Cold Water
- PW Pure Water
- ES Emergency Shower

CONTROLS AND SENSOR SYSTEMS

Imaging

Space Code: 4.1
 NASF/Unit: 1,200 sf
 Occupants:
 No. of Spaces: 1

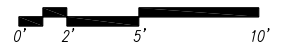
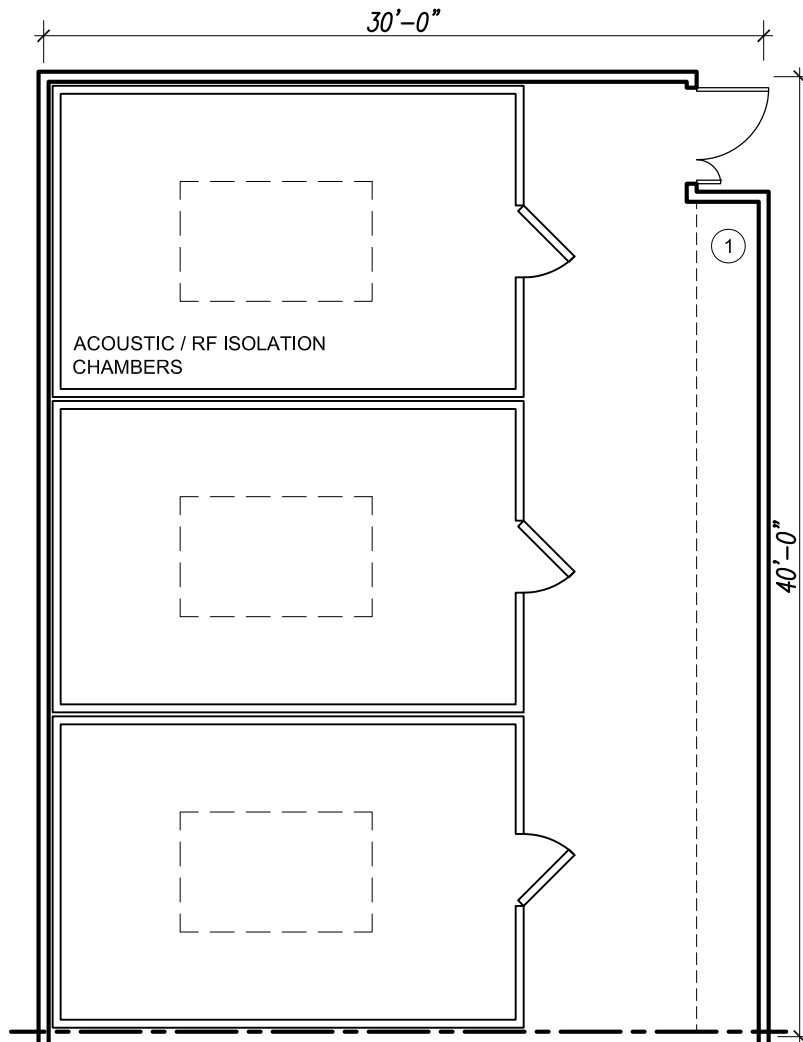

CASEWORK

1. Bench - Standing Height
2. Bench - Sitting Height
3. Bench - Movable
4. Wall Shelves
5. Wall Cabinet
6. Tall Storage Cabinet
7. Movable Table
8. Fixed Table
9. Sink

EQUIPMENT

20. Fume Hood
21. Biological Safety Cabinet
22. Refrigerator
23. Freezer
24. Incubator
25. Autoclave
26. Glassware Washer
27. Overhead Projector
28. Fluorescence Microscope
29. Optical Table
30. Equipment Rack
31. Curtains / Track

FURNISHINGS

40. Projection Screen
41. Whiteboard
42. Curtains & Tracks

SERVICES

- ⌀ Power
- ▽ Data
- G Gas
- A Air
- V Vacuum
- CW Cold Water
- PW Pure Water
- ES Emergency Shower

CONTROLS AND SENSOR SYSTEMS

Water Lab

Space Code: 4.2
 NASF/Unit: 1,000 sf
 Occupants:
 No. of Spaces: 1

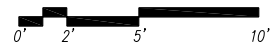
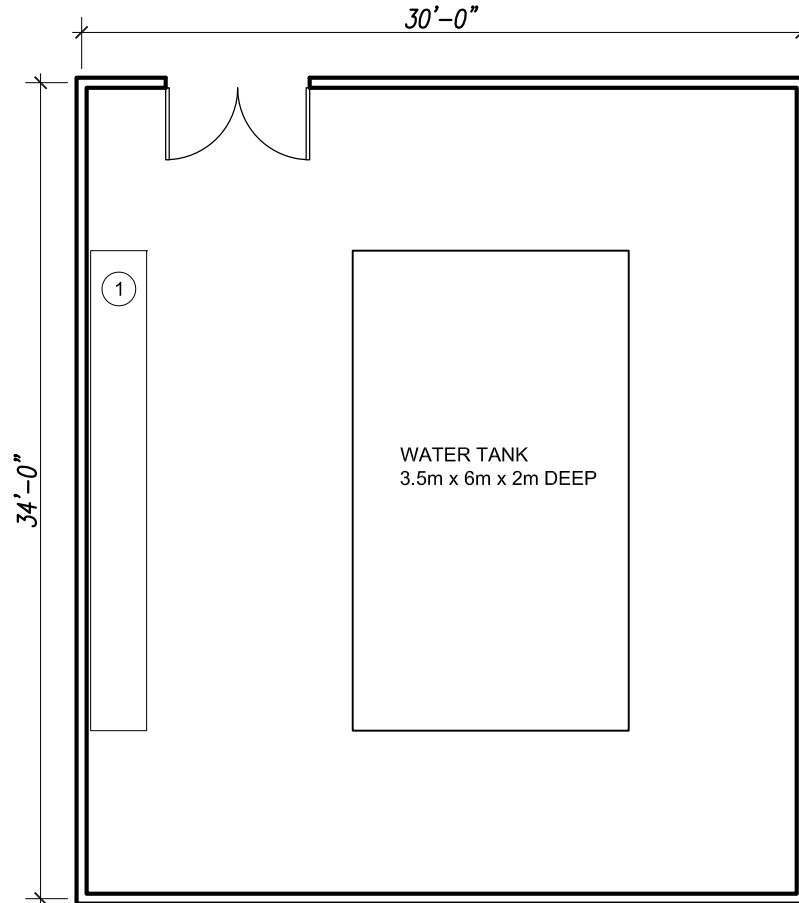

CASEWORK

1. Bench - Standing Height
2. Bench - Sitting Height
3. Bench - Movable
4. Wall Shelves
5. Wall Cabinet
6. Tall Storage Cabinet
7. Movable Table
8. Fixed Table
9. Sink

EQUIPMENT

20. Fume Hood
21. Biological Safety Cabinet
22. Refrigerator
23. Freezer
24. Incubator
25. Autoclave
26. Glassware Washer
27. Overhead Projector
28. Fluorescence Microscope
29. Optical Table
30. Equipment Rack
31. Curtains / Track

FURNISHINGS

40. Projection Screen
41. Whiteboard
42. Curtains & Tracks

SERVICES

- ⌀ Power
- ▽ Data
- G Gas
- A Air
- V Vacuum
- CW Cold Water
- PW Pure Water
- ES Emergency Shower

CONTROLS AND SENSOR SYSTEMS

Lab Support

Space Code: 4.3
 NASF/Unit: 400 sf
 Occupants:
 No. of Spaces: 1

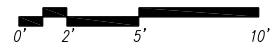
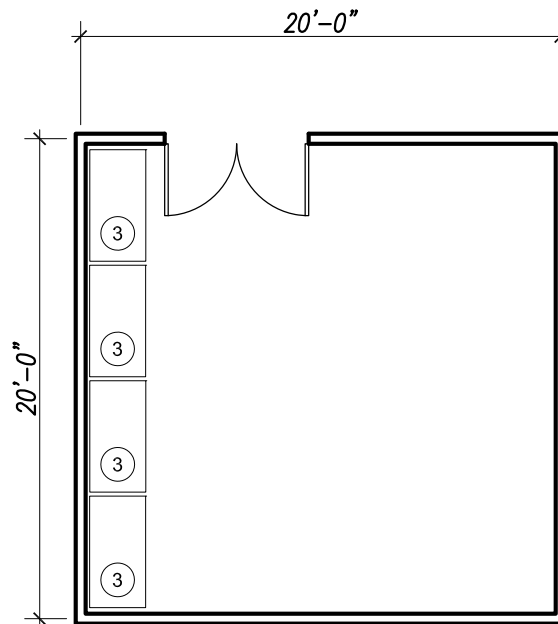

CASEWORK

1. Bench - Standing Height
2. Bench - Sitting Height
3. Bench - Movable
4. Wall Shelves
5. Wall Cabinet
6. Tall Storage Cabinet
7. Movable Table
8. Fixed Table
9. Sink

EQUIPMENT

20. Fume Hood
21. Biological Safety Cabinet
22. Refrigerator
23. Freezer
24. Incubator
25. Autoclave
26. Glassware Washer
27. Overhead Projector
28. Fluorescence Microscope
29. Optical Table
30. Equipment Rack
31. Curtains / Track

FURNISHINGS

40. Projection Screen
41. Whiteboard
42. Curtains & Tracks

SERVICES

- ⌀ Power
- ▽ Data
- G Gas
- A Air
- V Vacuum
- CW Cold Water
- PW Pure Water
- ES Emergency Shower

CONTROLS AND SENSOR SYSTEMS

Grad Student / Post-Doc Offices

Space Code: 4.4
NASF/Unit: 200 sf
Occupants: 4-6
No. of Spaces: 5

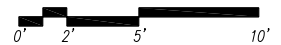
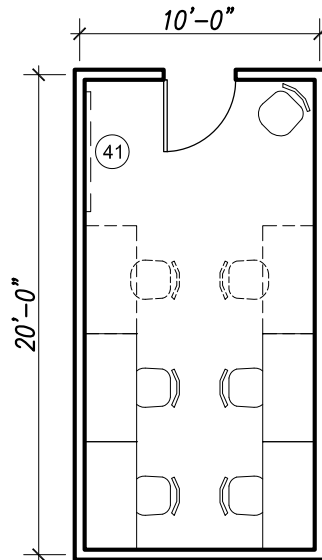

CASEWORK

1. Bench - Standing Height
2. Bench - Sitting Height
3. Bench - Movable
4. Wall Shelves
5. Wall Cabinet
6. Tall Storage Cabinet
7. Movable Table
8. Fixed Table
9. Sink

EQUIPMENT

20. Fume Hood
21. Biological Safety Cabinet
22. Refrigerator
23. Freezer
24. Incubator
25. Autoclave
26. Glassware Washer
27. Overhead Projector
28. Fluorescence Microscope
29. Optical Table
30. Equipment Rack
31. Curtains / Track

FURNISHINGS

40. Projection Screen
41. Whiteboard
42. Curtains & Tracks

SERVICES

- ⌀ Power
- ▽ Data
- G Gas
- A Air
- V Vacuum
- CW Cold Water
- PW Pure Water
- ES Emergency Shower

CONTROLS AND SENSOR SYSTEMS

Meeting / Breakout Space

Space Code: 4.5
 NASF/Unit: 400 sf
 Occupants: -
 No. of Spaces: 2

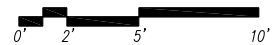
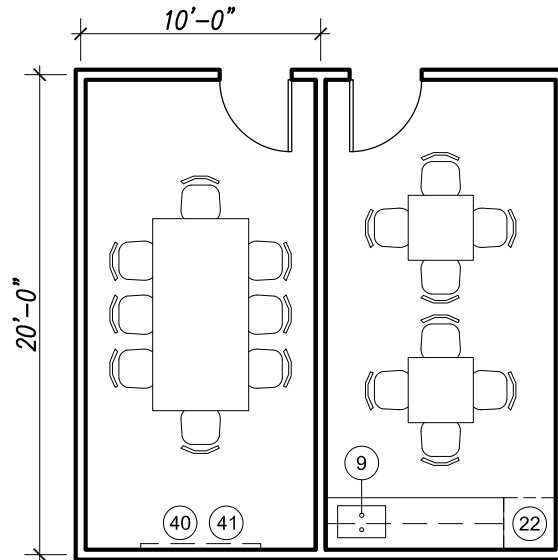

CASEWORK

1. Bench - Standing Height
2. Bench - Sitting Height
3. Bench - Movable
4. Wall Shelves
5. Wall Cabinet
6. Tall Storage Cabinet
7. Movable Table
8. Fixed Table
9. Sink

EQUIPMENT

20. Fume Hood
21. Biological Safety Cabinet
22. Refrigerator
23. Freezer
24. Incubator
25. Autoclave
26. Glassware Washer
27. Overhead Projector
28. Fluorescence Microscope
29. Optical Table
30. Equipment Rack
31. Curtains / Track

FURNISHINGS

40. Projection Screen
41. Whiteboard
42. Curtains & Tracks

SERVICES

- ⊕ Power
- ▽ Data
- G Gas
- A Air
- V Vacuum
- CW Cold Water
- PW Pure Water
- ES Emergency Shower

CONTROLS AND SENSOR SYSTEMS

Smart Building Office

Space Code: 4.6
 NASF/Unit: 250 sf
 Occupants: 1
 No. of Spaces: 1

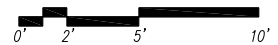
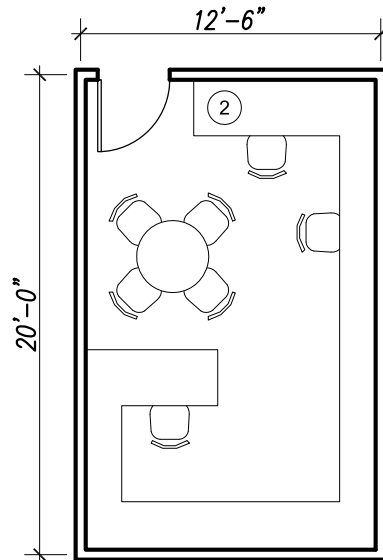

CASEWORK

1. Bench - Standing Height
2. Bench - Sitting Height
3. Bench - Movable
4. Wall Shelves
5. Wall Cabinet
6. Tall Storage Cabinet
7. Movable Table
8. Fixed Table
9. Sink

EQUIPMENT

20. Fume Hood
21. Biological Safety Cabinet
22. Refrigerator
23. Freezer
24. Incubator
25. Autoclave
26. Glassware Washer
27. Overhead Projector
28. Fluorescence Microscope
29. Optical Table
30. Equipment Rack
31. Curtains / Track

FURNISHINGS

40. Projection Screen
41. Whiteboard
42. Curtains & Tracks

SERVICES

- ⌀ Power
- ▽ Data
- G Gas
- A Air
- V Vacuum
- CW Cold Water
- PW Pure Water
- ES Emergency Shower